

LOWER LEVEL

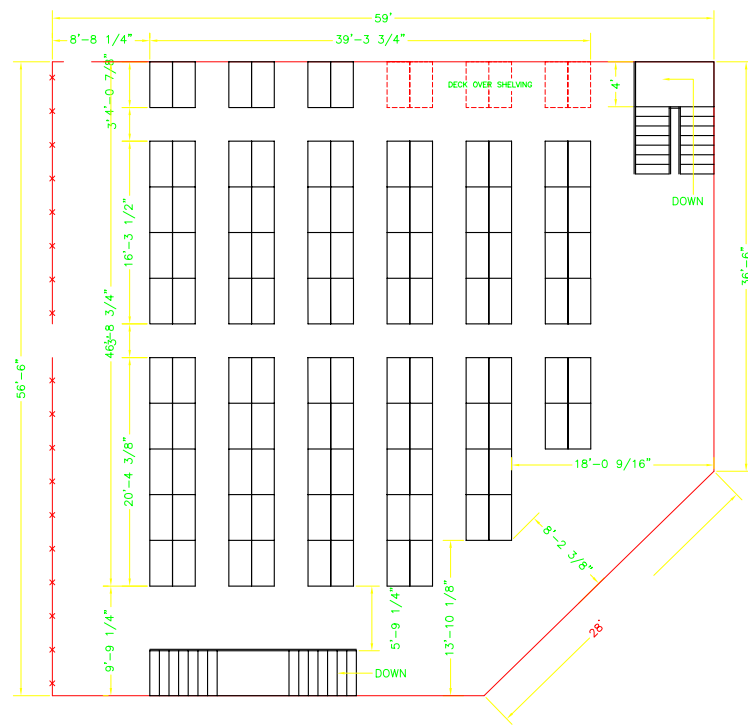

UPPER LEVEL



STRUCTURAL ELEMENTS

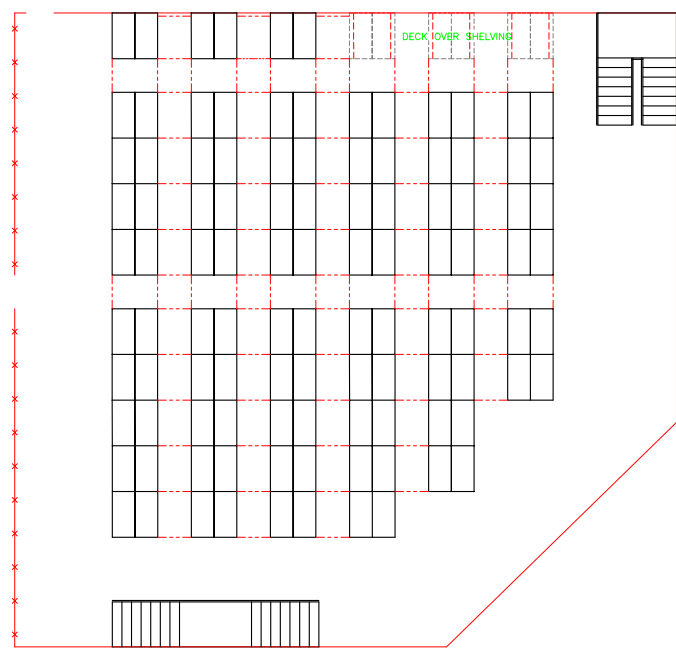

AISLE SUPPORT PLACEMENT

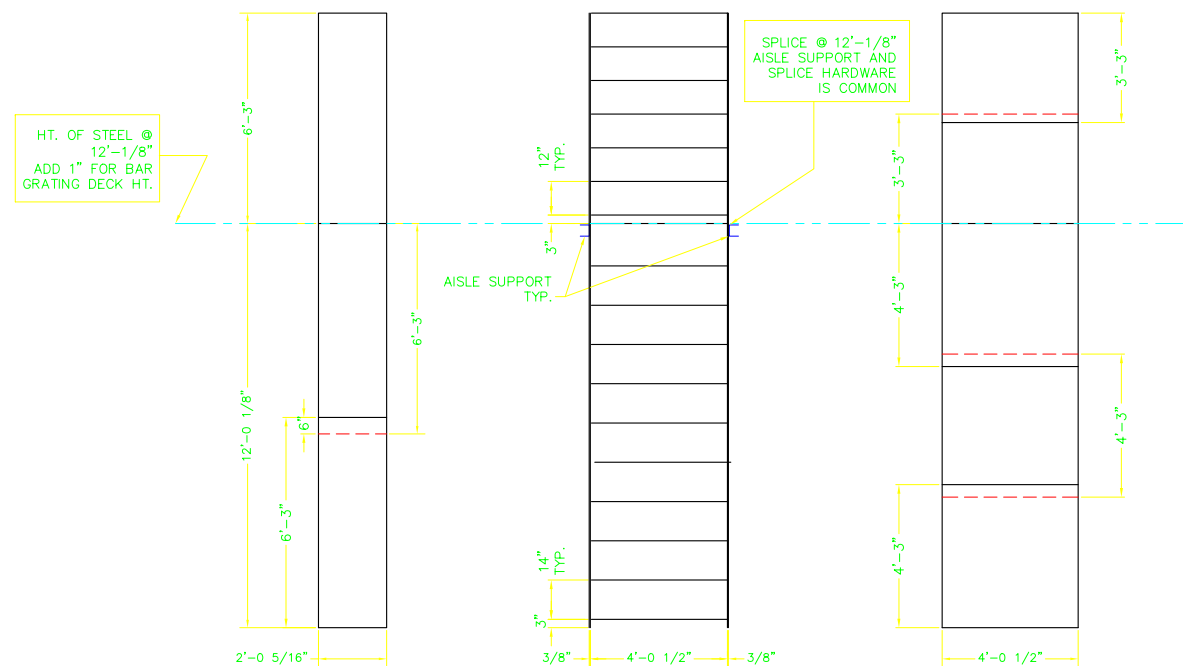

SIDE ELEVATION

SHELF LOCATIONS

BACK PANEL LOCATIONS

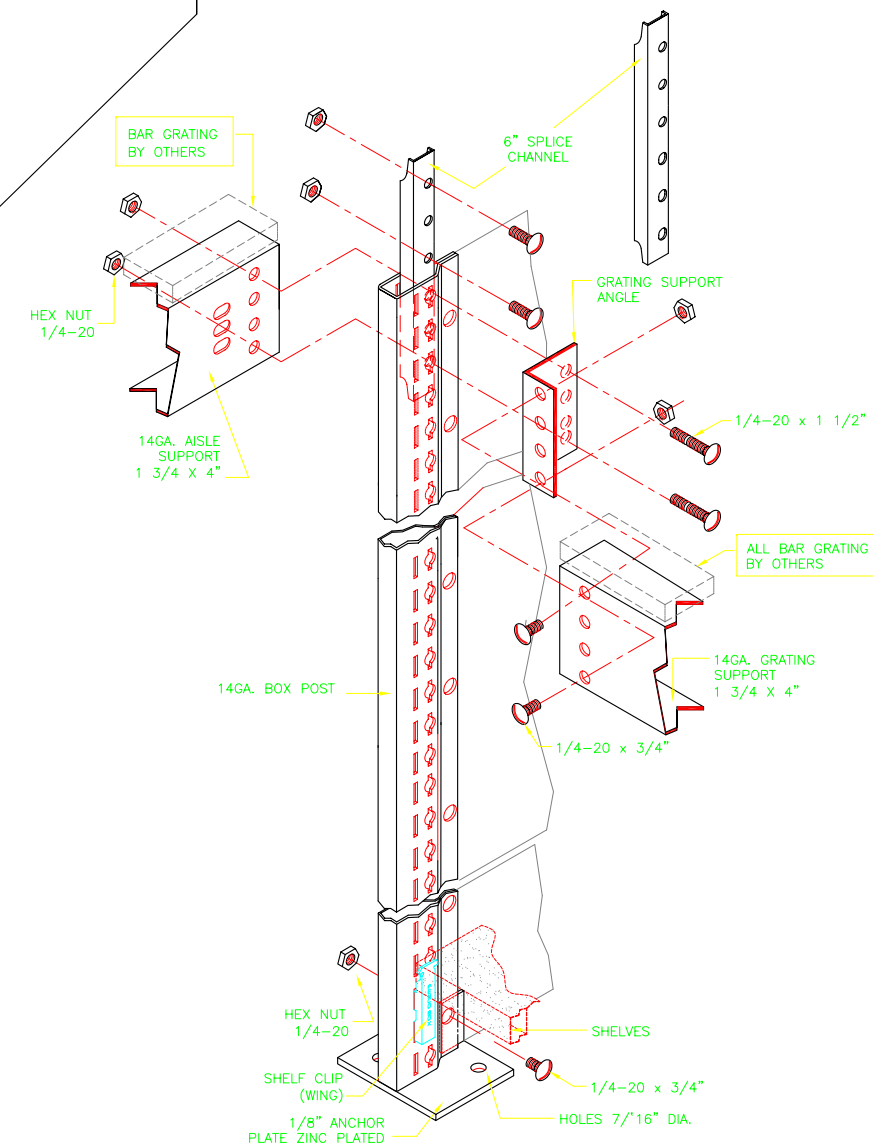

ASSEMBLY DETAIL

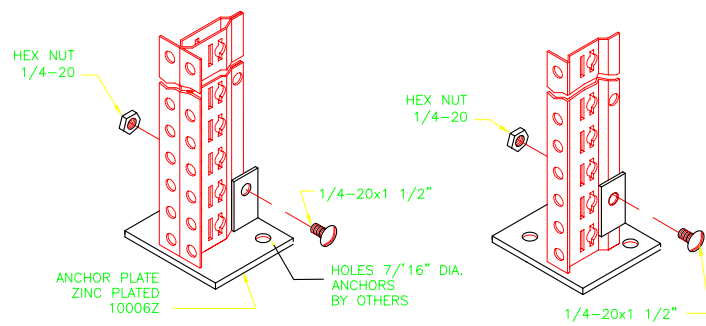

INTERMEDIATE POST

AISLE-END REAR POST

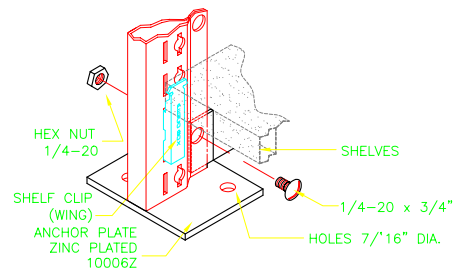

FRONT BOX POST

NOTE:
BACK TO BACK AND
SIDE TO SIDE CONDITIONS
USE COMMON BRACING

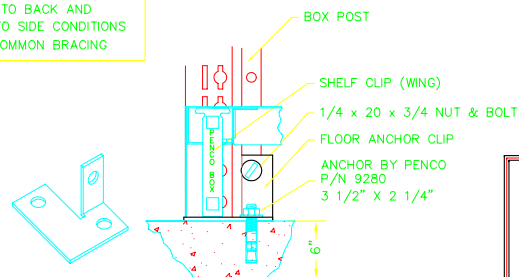

This drawing is proprietary to Penco Products Inc. the information contained herein shall not be disclosed to unauthorized personnel without written consent from Penco Products Inc.

A	LP	REVISION	4/26/04
No.	By	Description	Date
Owner:			
Project:		 Penco Products, Inc. Subsidiary of Veeger Corporation OAKS PLANT Brown Avenue, Oaks, PA 19456	
Location:		Drawn by:	Date:
Title:		LP:	
Erector:		Checked:	
		Approved:	
File:		Drawing No:	
SHEET		of	