

THREE LOUVERS EA.
TOP DOOR

UPPER DOORS OPEN BY
UNLATCHING IN LOWER
COMPARTMENT AND CAN
BE CLOSED INDEPENDENTLY

ALUMINUM NO. PLATE

SIX LOUVERS @ TOP
& BOTTOM EA. DOOR

TWO SGL. PRONG WALL
HOOKS EA. OPENING

LOCK HOLE COVER PLATE

CHROME PLATED HANDLE
WITH PADLOCK EYE

16GA. FRAME W/ 18GA.
DOORS

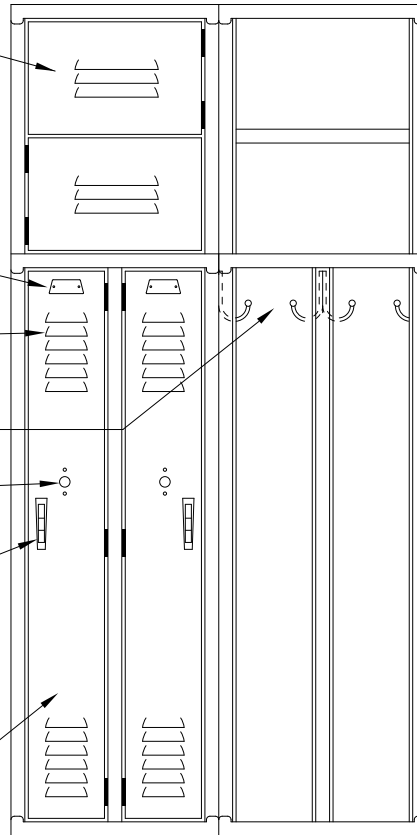

ELEVATION

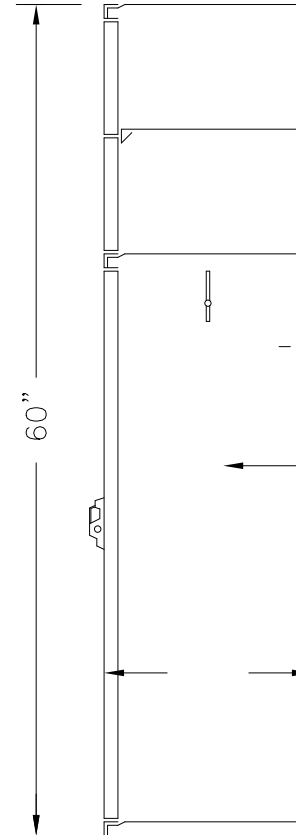

24GA. BODY &
TIER HEADS

SECTION @ WALL

60" HIGH TWO PERSON VANGUARD KNOCKDOWN LOCKER

TYPICAL FOR 15" & 18" WIDE, ALLOW 1/16" CREEPAGE PER FRAME
TYPICAL FOR 12" & 15" DEEP

This drawing shows a standard Penco Product. Any modifications to the product must be approved by Penco Engineering. 8/6/2001



151560V2P.dwg

UPPER DOORS OPEN BY
UNLATCHING IN LOWER
COMPARTMENT AND CAN
BE CLOSED INDEPENDENTLY

THREE LOUVERS EA.
TOP DOOR

ALUMINUM NO. PLATE

SIX LOUVERS @ TOP
& BOTTOM EA. DOOR

TWO SGL. PRONG WALL
HOOKS EA. OPENING

LOCK HOLE COVER PLATE

CHROME PLATED HANDLE
WITH PADLOCK EYE

16GA. FRAME W/ 18GA.
DOORS

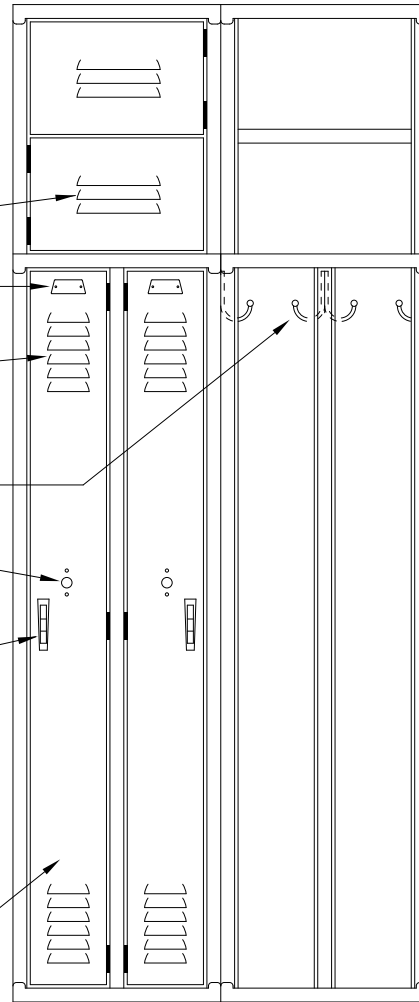

ELEVATION

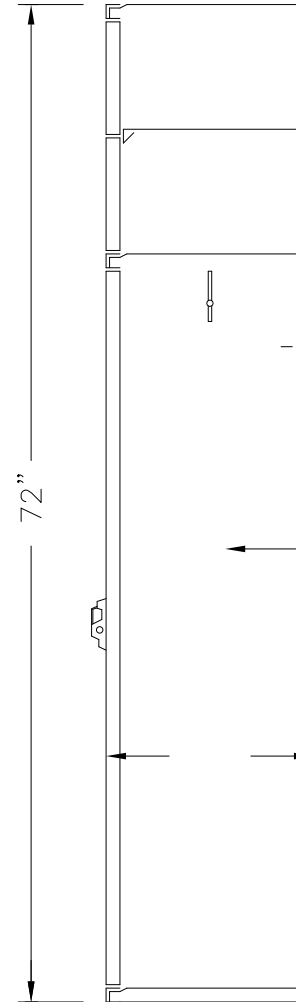

24GA. BODY &
TIER HEADS

SECTION @ WALL

72" TWO PERSON VANGUARD KNOCKDOWN LOCKER

TYPICAL FOR 15" & 18" WIDE, ALLOW 1/16" CREEPAGE PER FRAME
TYPICAL FOR 12" & 15" DEEP

This drawing shows a standard Penco Product. Any modifications to the product must be approved by Penco Engineering. 8/6/2001



151572V2P.dwg

THREE LOUVERS EA.
TOP DOOR

UPPER DOORS OPEN BY
UNLATCHING IN LOWER
COMPARTMENT AND CAN
BE CLOSED INDEPENDENTLY

ALUMINUM NO. PLATE

SIX LOUVERS @ TOP
& BOTTOM EA. DOOR

ONE COAT ROD &
TWO SGL. PRONG WALL
HOOKS EA. OPENING

LOCK HOLE COVER PLATE

CHROME PLATED HANDLE
WITH PADLOCK EYE

16GA. FRAME W/ 18GA.
DOORS

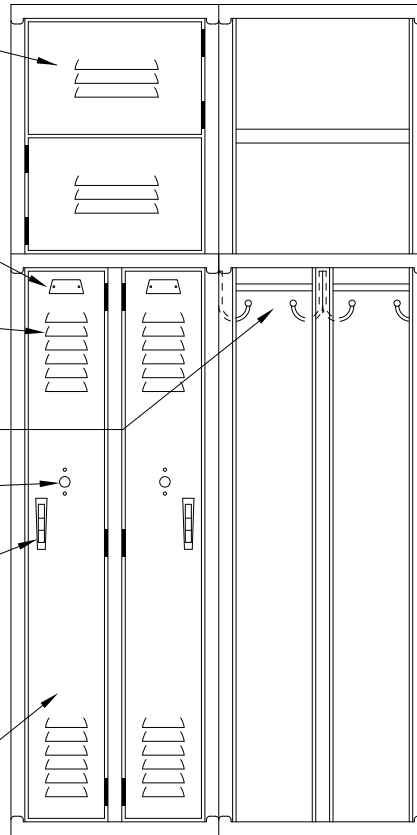

ELEVATION

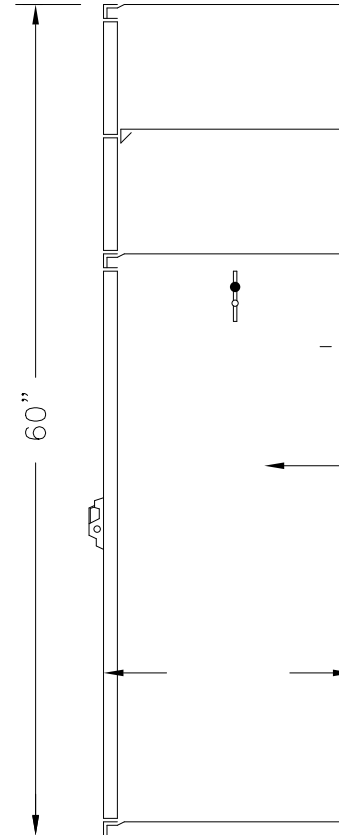

24GA. BODY &
TIER HEADS

SECTION @ WALL

60" HIGH TWO PERSON VANGUARD KNOCKDOWN LOCKER

TYPICAL FOR 15" & 18" WIDE, ALLOW 1/16" CREEPAGE PER FRAME
TYPICAL FOR 18" & 21" DEEP

This drawing shows a standard Penco Product. Any modifications to the product must be approved by Penco Engineering. 8/6/2001



151860V2P.dwg

UPPER DOORS OPEN BY
UNLATCHING IN LOWER
COMPARTMENT AND CAN
BE CLOSED INDEPENDENTLY

THREE LOUVERS EA.
TOP DOOR

ALUMINUM NO. PLATE

SIX LOUVERS @ TOP
& BOTTOM EA. DOOR

ONE COAT ROD &
TWO SGL. PRONG WALL
HOOKS EA. OPENING

LOCK HOLE COVER PLATE

CHROME PLATED HANDLE
WITH PADLOCK EYE

16GA. FRAME W/ 18GA.
DOORS

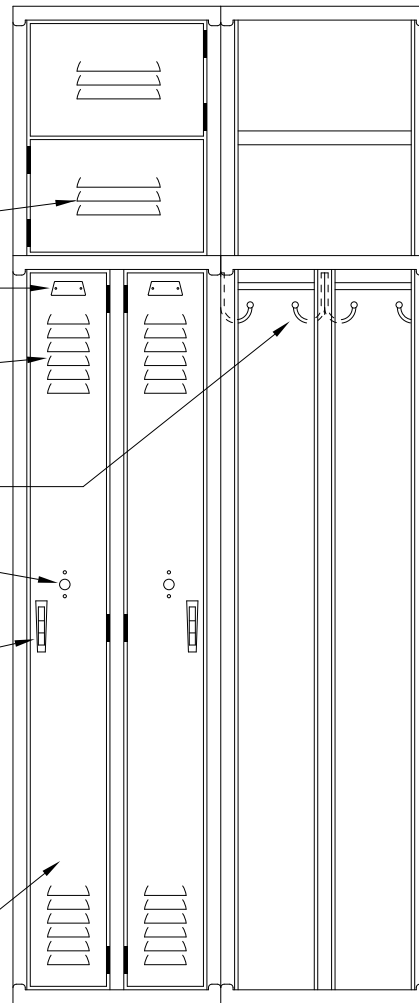

ELEVATION

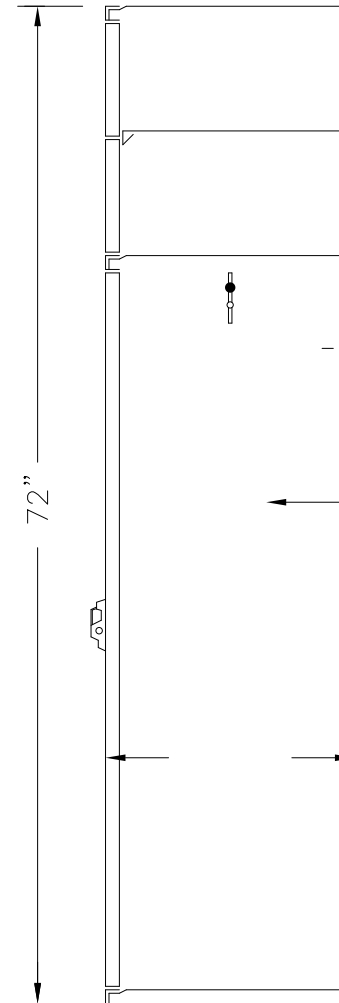

24GA. BODY &
TIER HEADS

SECTION @ WALL

72" HIGH TWO PERSON VANGUARD KNOCKDOWN LOCKER

TYPICAL FOR 15" & 18" WIDE, ALLOW 1/16" CREEPAGE PER FRAME
TYPICAL FOR 18" & 21" DEEP

This drawing shows a standard Penco Product. Any modifications to the product must be approved by Penco Engineering. 8/6/2001



151872V2P.dwg

ALUMINUM NO. PLATE

SIX LOUVERS @ TOP
& BOTTOM EA. DOOR

THREE SGL. PRONG WALL
HOOKS EA. OPENING

LOCK HOLE COVER PLATE

CHROME PLATED HANDLE
WITH PADLOCK EYE

16GA. FRAME W/ 18GA.
DOORS

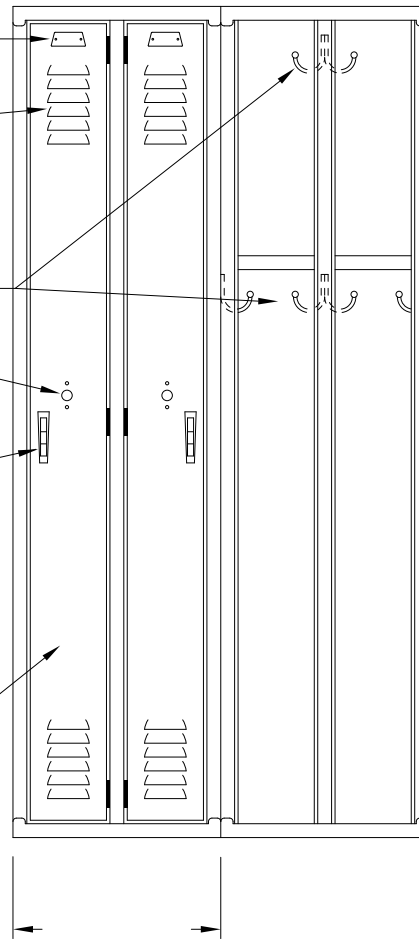

ELEVATION

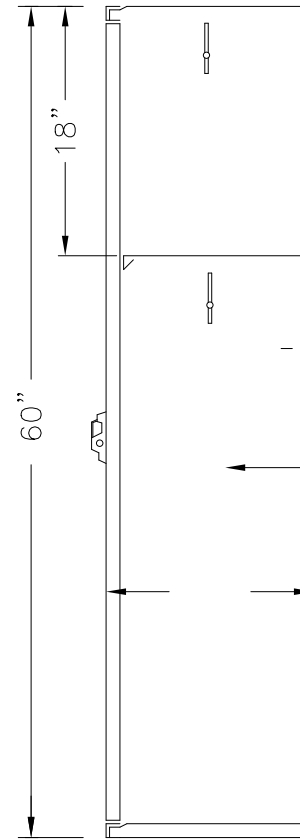

24GA. BODY &
TIER HEADS

SECTION @ WALL

60" DUPLEX VANGUARD KNOCKDOWN LOCKER
TYPICAL FOR 15" & 18" WIDE, ALLOW 1/16" CREEPAGE PER FRAME
15" DEEP

This drawing shows a standard Penco Product. Any modifications to the product must be approved by Penco Engineering. 8/6/2001



151560VDX.dwg

ALUMINUM NO. PLATE
SIX LOUVERS @ TOP
& BOTTOM EA. DOOR

THREE SGL. PRONG WALL
HOOKS EA. OPENING

LOCK HOLE COVER PLATE

CHROME PLATED HANDLE
WITH PADLOCK EYE

16GA. FRAME W/ 18GA.
DOORS

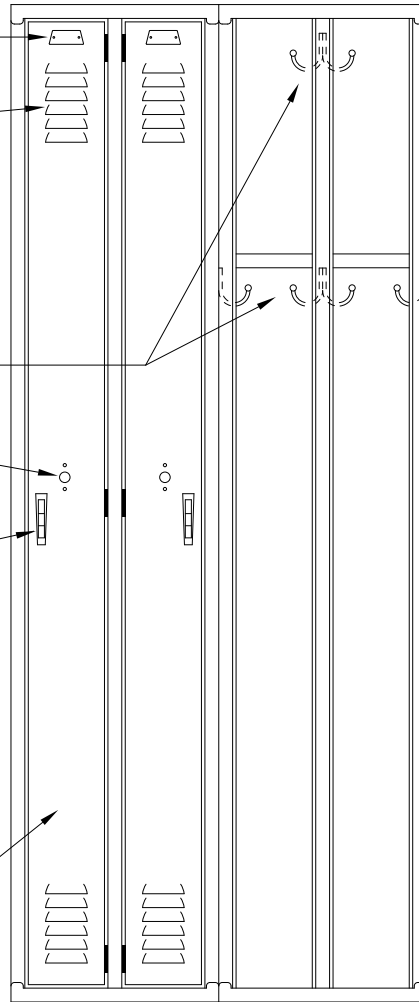

ELEVATION

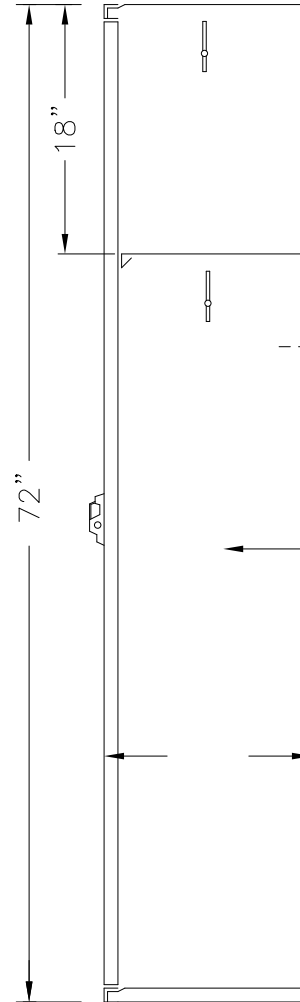

24GA. BODY &
TIER HEADS

SECTION @ WALL

72" DUPLEX VANGUARD KNOCKDOWN LOCKER

15" WIDE, ALLOW 1/16" CREEPAGE PER FRAME
15" DEEP

This drawing shows a standard Penco Product. Any modifications to the product must be approved by Penco Engineering. 8/6/2001



ALUMINUM NO. PLATE

SIX LOUVERS @ TOP
& BOTTOM EA. DOOR

ONE COAT ROD &
THREE SGL. PRONG WALL
HOOKS EA. OPENING

LOCK HOLE COVER PLATE

CHROME PLATED HANDLE
WITH PADLOCK EYE

16GA. FRAME W/ 18GA.
DOORS

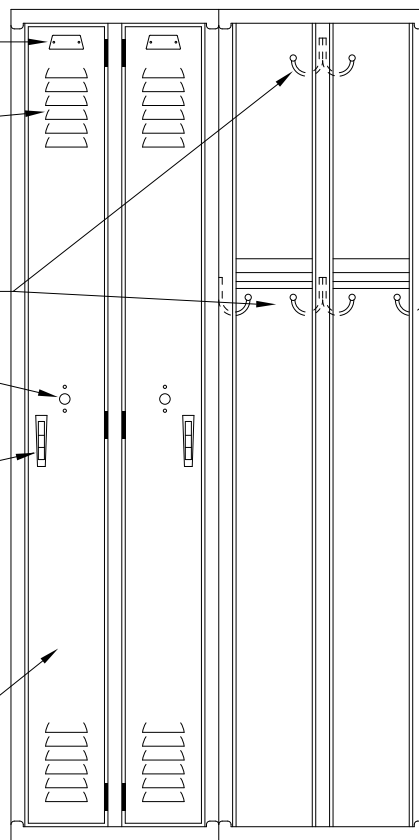

ELEVATION

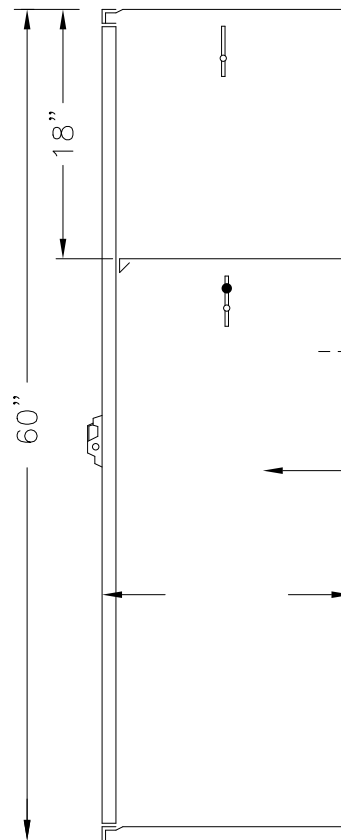

60"

18"

24GA. BODY &
TIER HEADS

SECTION @ WALL

60" DUPLEX VANGUARD KNOCKDOWN LOCKER

TYPICAL FOR 15" & 18" WIDE, ALLOW 1/16" CREEPAGE PER FRAME
TYPICAL FOR 18" & 21" DEEP

This drawing shows a standard Penco Product. Any modifications to the product must be approved by Penco Engineering. 8/6/2001



ALUMINUM NO. PLATE

SIX LOUVERS @ TOP
& BOTTOM EA. DOOR

ONE COAT ROD &
THREE SGL. PRONG WALL
HOOKS EA. OPENING

LOCK HOLE COVER PLATE

CHROME PLATED HANDLE
WITH PADLOCK EYE

16GA. FRAME W/ 18GA.
DOORS

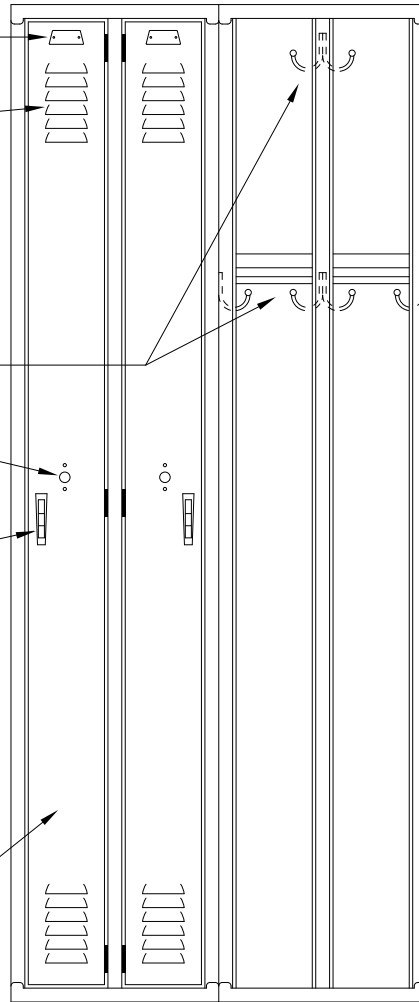

ELEVATION

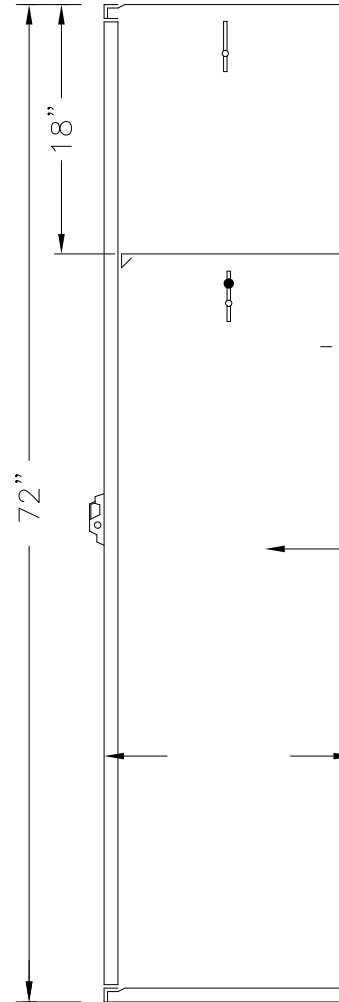

SECTION @ WALL

24GA. BODY &
TIER HEADS

72" DUPLEX VANGUARD KNOCKDOWN LOCKER

TYPICAL 15" & 18" WIDE, ALLOW 1/16" CREEPAGE PER FRAME
18" & 21" DEEP

This drawing shows a standard Penco Product. Any modifications to the product must be approved by Penco Engineering. 8/6/2001

